

Product Parts Breakdown

▲ Specify Finish

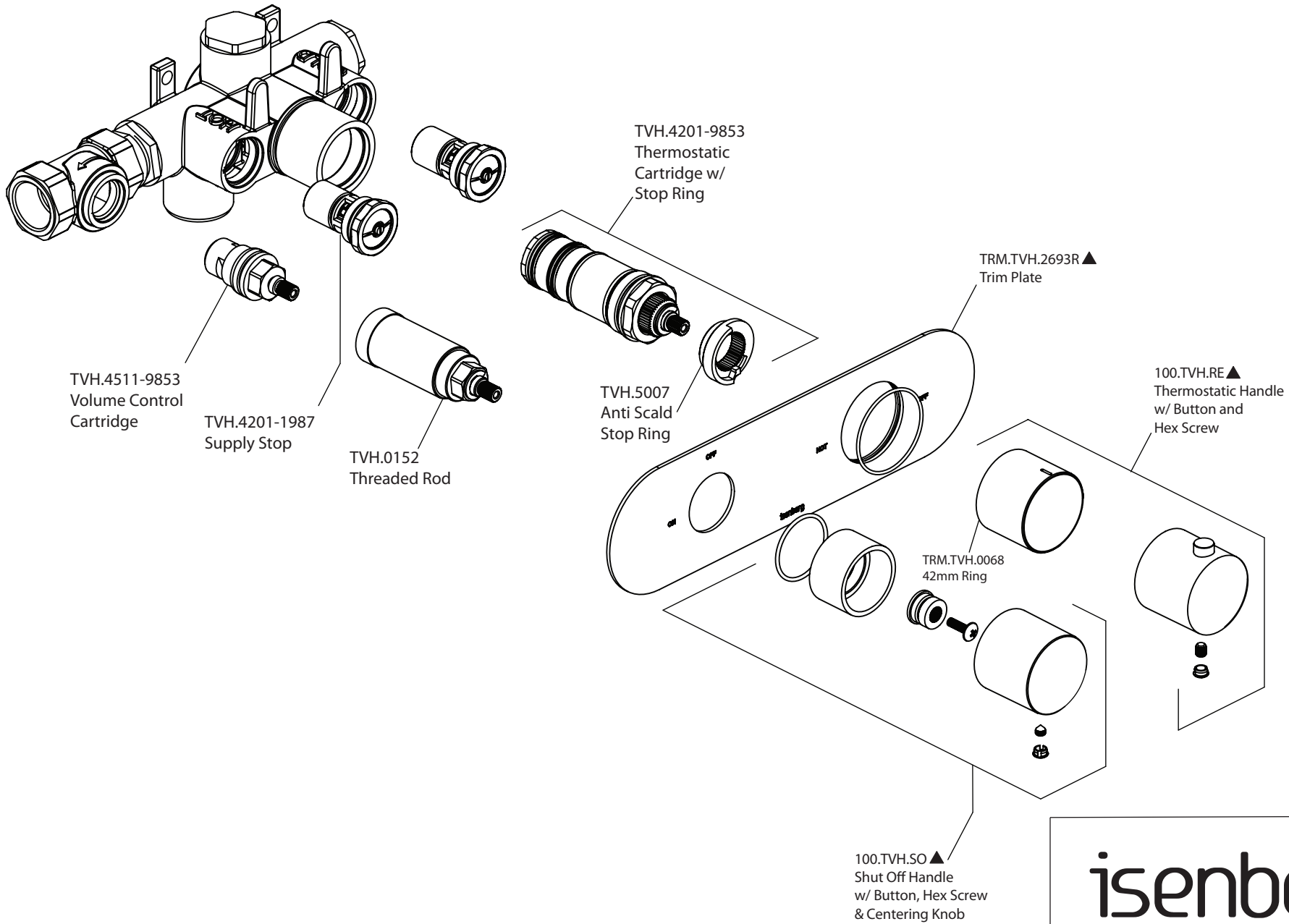

isenberg
innovation+design

100.2693

Ver 2.53